

Series 1200

European profile cylinder lock RS4

Description

European profile cylinder lock for professional applications



Technical specifications

- Body material: brass
- 28° inclined cam for anti-pull function

Resistant to:

- Bumping
- Picking
- Drilling

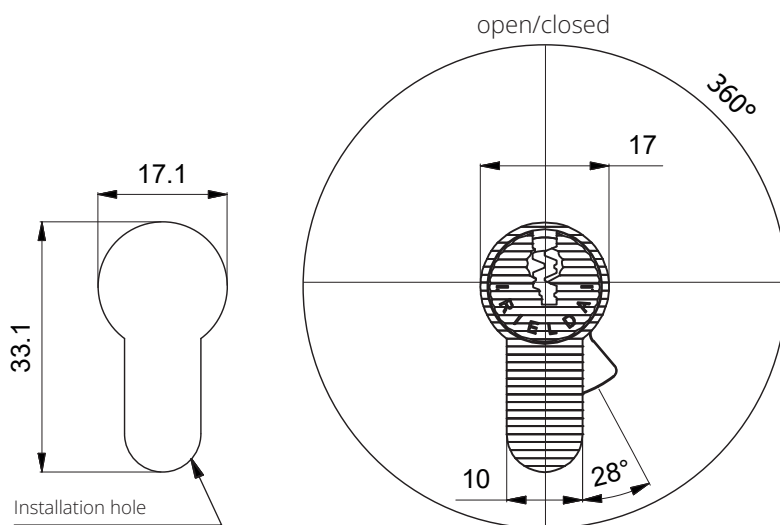
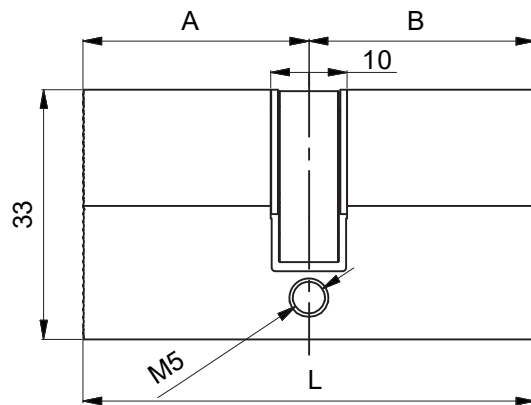

Available dimensions

L	A	B
62	31	31
66	31	35
71	31	40
76	31	45
81	31	50
66	35	31
70	35	35
75	35	40
80	35	45
85	35	50
71	40	31
75	40	35
80	40	40
85	40	45
90	40	50
76	45	31
80	45	35
85	45	40
90	45	45
95	45	50
81	50	31
85	50	35
90	50	40
95	50	45
100	50	50