

Series 400 - 500 - 600

## Model 458 RS1

### Description

Mechanically Re-Programmable cam lock with 90° rotation for professional applications



### Technical specifications

- System: mechanically Re-Programmable with 7 million different keys
- Body material: brass
- Rotation: 90° clockwise

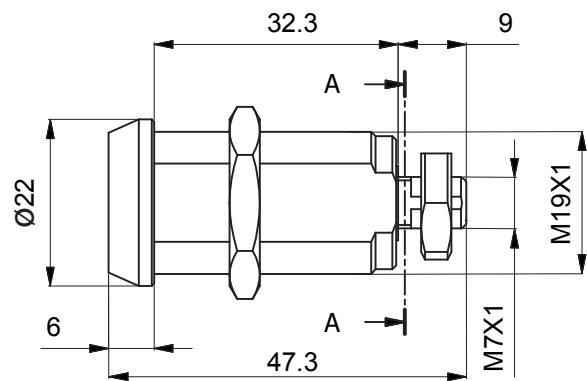

### Resistant to:

- Bumping
- Picking
- Drilling

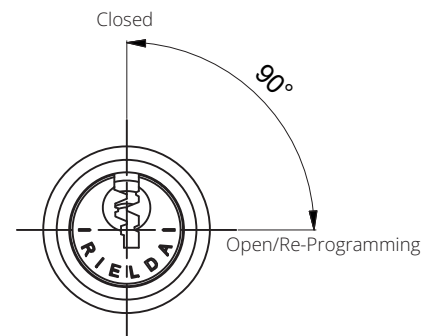

### Installation

- Installation hole  $\varnothing$  19mm
- Thread M19 x 1
- Thread M7 x 1

