

Series 400 - 500

Model 519 RS7

Description

Electromechanical Re-Programmable security cam lock with all the advantages of digital control, with 90° rotation for professional applications



Technical specifications

- No batteries and no electrical line connections required
- Body material: brass
- Rotation: 90° clockwise

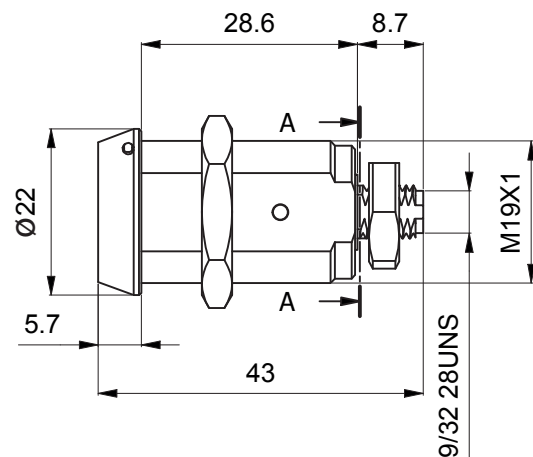

Resistant to:

- Bumping
- Picking
- Drilling
- Opening by shock
- Tampering
- Rotor extraction
- Electrical discharges
- Forced key opening

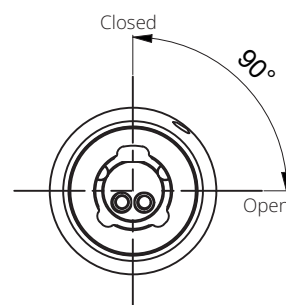

Installation

- Installation hole \varnothing 19mm
- Thread M19 x 1
- Thread 9/32 28UNS

