

Series 400 - 500 - 600

Model 592 RS1

Description

Mechanically Re-Programmable cam lock with 90° rotation for professional applications



Technical specifications

- System: mechanically Re-Programmable with 7 million different keys
- Body material: brass
- Rotation: 90° counterclockwise

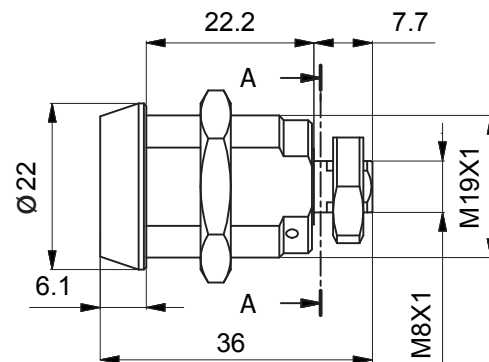

Resistant to:

- Bumping
- Picking
- Drilling

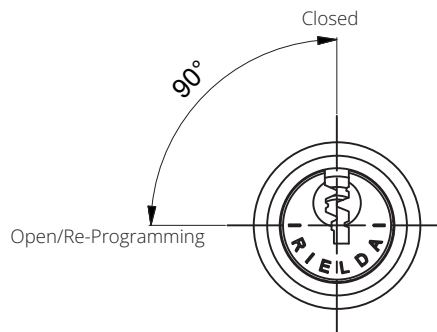

Installation

- Installation hole \varnothing 19mm
- Thread M19 x 1
- Thread M8 x 1

