

Series 800

Model 801-87 RS1

Description

Mechanically Re-Programmable armored padlock with 132° rotation for professional applications

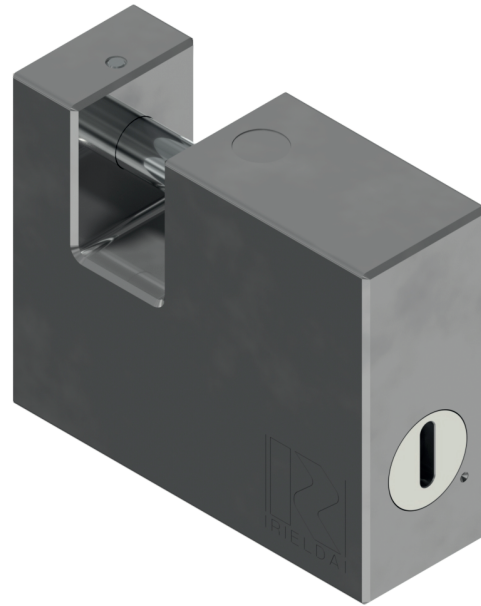

Technical specifications

- System: mechanically Re-Programmable with 7 million different keys
- Body material: hardened steel
- Protective rotating shield
- Rotation: 132° clockwise

Resistant to:

- Bumping
- Picking
- Drilling

